



## CONTENTS

1. SAFETY INFORMATION.....	3
2. SAFETY INSTRUCTIONS.....	4
3. PRODUCT DESCRIPTION.....	7
4. TECHNICAL DATA.....	8
5. INSTALLATION.....	8
6. CONTROL PANEL.....	11
7. PROGRAMME CHART.....	11
8. OPTIONS.....	15
9. SETTINGS.....	16
10. BEFORE FIRST USE.....	17
11. DAILY USE.....	17
12. HINTS AND TIPS.....	20
13. CARE AND CLEANING.....	21
14. TROUBLESHOOTING.....	24
15. CONSUMPTION VALUES.....	26
16. QUICK GUIDE.....	28

## WE'RE THINKING OF YOU

Thank you for purchasing an Electrolux appliance. You've chosen a product that brings with it decades of professional experience and innovation. Ingenious and stylish, it has been designed with you in mind. So whenever you use it, you can be safe in the knowledge that you'll get great results every time.

Welcome to Electrolux.

**Visit our website to:**



Get usage advice, brochures, trouble shooter, service and repair information:  
**[www.electrolux.com/support](http://www.electrolux.com/support)**



Register your product for better service:  
**[www.registerelectrolux.com](http://www.registerelectrolux.com)**



Buy Accessories, Consumables and Original spare parts for your appliance:  
**[www.electrolux.com/shop](http://www.electrolux.com/shop)**

## CUSTOMER CARE AND SERVICE

Always use original spare parts.

When contacting our Authorised Service Centre, ensure that you have the following data available: Model, PNC, Serial Number.

The information can be found on the rating plate.

 Warning / Caution-Safety information

 General information and tips

 Environmental information

Subject to change without notice.

## 1. ⚠ SAFETY INFORMATION

Before the installation and use of the appliance, carefully read the supplied instructions. The manufacturer is not responsible for any injuries or damage that are the result of incorrect installation or usage. Always keep the instructions in a safe and accessible location for future reference.

### 1.1 Children and vulnerable people safety

- This appliance can be used by children aged from 8 years and above and persons with reduced physical, sensory or mental capabilities or lack of experience and knowledge if they have been given supervision or instruction concerning the use of the appliance in a safe way and understand the hazards involved.
- Children between 3 and 8 years of age and persons with very extensive and complex disabilities shall be kept away from the appliance unless continuously supervised.
- Children of less than 3 years of age should be kept away from the appliance unless continuously supervised.
- Children should be supervised to ensure that they do not play with the appliance.
- Keep all packaging away from children and dispose of it appropriately.
- Keep detergents away from children.
- Keep children and pets away from the appliance when the door is open.
- Children shall not carry out cleaning and user maintenance of the appliance without supervision.

### 1.2 General Safety

- Do not change the specification of this appliance.
- This appliance is intended to be used in household and similar applications such as:

- staff kitchen areas in shops, offices and other working environments;
  - by clients in hotels, motels, bed & breakfast and other residential type environments;
  - areas for communal use in blocks of flats or in launderettes.
- The appliance maximum load is 6 kg. Do not exceed the maximum load of each programme (refer to the “Programmes” chapter).
  - The operating water pressure at the water entry point from the outlet connection must be between 0.5 bar (0.05 MPa) and 8 bar (0.8 MPa).
  - The ventilation opening in the base must not be covered by a carpet, mat, or any floor covering.
  - The appliance must be connected to the water mains using the new supplied hose sets, or other new hose sets supplied by the Authorised Service Centre.
  - Old hose sets must not be reused.
  - If the mains power supply cable is damaged, it must be replaced by the manufacturer, its Authorised Service Centre or similarly qualified persons to avoid an electrical hazard.
  - Before any maintenance operation, deactivate the appliance and disconnect the mains plug from the socket.
  - Do not use high pressure water sprays and/or steam to clean the appliance.
  - Clean the appliance with a moist cloth. Use only neutral detergents. Do not use abrasive products, abrasive cleaning pads, solvents or metal objects.

## 2. SAFETY INSTRUCTIONS

### 2.1 Installation



The installation must comply with relevant national regulations.

- Remove all the packaging and the transit bolts including rubber bush with plastic spacer.
- Keep the transit bolts in a safe place. If the appliance is to be moved in the future they must be reattached to lock the drum to prevent an internal damage.
- Always take care when moving the appliance as it is heavy. Always use safety gloves and enclosed footwear.

- Follow the installation instructions supplied with the appliance.
- Do not install or use a damaged appliance.
- Do not install or use the appliance where the temperature can be less than 0°C or where it is exposed to the weather.
- The floor area on which the appliance is to be installed must be flat, stable, heat resistant and clean.
- Make sure that there is air circulation between the appliance and the floor.
- When the appliance is in its permanent position, check if it is levelled correctly with the aid of a spirit level. If it is not, adjust the feet accordingly.
- Do not install the appliance directly above a floor drain.
- Do not spray water on the appliance and do not expose it to excessive humidity.
- Do not install the appliance where the appliance lid cannot be fully opened.
- Do not put a closed container to collect possible water leakage under the appliance. Contact the Authorised Service Centre to ensure which accessories can be used.

## 2.2 Electrical connection



### **WARNING!**

Risk of fire and electric shock.

- The appliance must be earthed.
- Always use a correctly installed shockproof socket.
- Make sure that the parameters on the rating plate are compatible with the electrical ratings of the mains power supply.
- Do not use multi-plug adapters and extension cables.
- Make sure not to cause damage to the mains plug and to the mains cable. Should the mains cable need to be replaced, this must be carried out by our Authorised Service Centre.
- Connect the mains plug to the mains socket only at the end of the installation. Make sure that there is access to the mains plug after the installation.

- Do not touch the mains cable or the mains plug with wet hands.
- Do not pull the mains cable to disconnect the appliance. Always pull the mains plug.

## 2.3 Water connection

- The inlet water shall not exceed 25 °C.
- Do not cause damage to the water hoses.
- Before connection to new pipes, pipes not used for a long time, where repair work has been carried out or new devices fitted (water meters, etc.), let the water flow until it is clean and clear.
- Ensure that there are no visible water leaks during and after the first use of the appliance.
- Do not use an extension hose if the inlet hose is too short. Contact the Authorised Service Centre for the replacement of the inlet hose.
- When unpacking the appliance, it is possible to see water flowing from the drain hose. This is due to the testing of the appliance with the use of water in the factory.
- You can extend the drain hose to maximum 400 cm. Contact the Authorised Service Centre for the other drain hose and the extension.
- Make sure that there is access to the tap after the installation.

## 2.4 Use



### **WARNING!**

Risk of injury, electric shock, fire, burns or damage to the appliance.

- Follow the safety instructions on the detergent packaging.
- Do not put flammable products or items that are wet with flammable products in, near or on the appliance.
- Do not wash fabrics which are heavily soiled with oil, grease or other greasy substances. It can damage rubber parts of the washing machine. Prewash such fabrics by hand before loading them into the washing machine.

- Make sure that all metal objects are removed from the laundry.

## 2.5 Service

- To repair the appliance contact the Authorised Service Centre. Use original spare parts only.
- Please note that self-repair or non-professional repair can have safety consequences and might void the guarantee.
- The following spare parts will be available for 10 years after the model has been discontinued: motor and motor brushes, transmission between motor and drum, pumps, shock absorbers and springs, washing drum, drum spider and related ball bearings, heaters and heating elements, including heat pumps, piping and related equipment including hoses, valves, filters and aquastops, printed circuit boards, electronic displays, pressure switches, thermostats and sensors, software and firmware including reset software, door, door hinge and seals, other seals, door locking assembly, plastic peripherals such as detergent dispensers. Please note that some of these spare parts are only available to professional

repairers, and that not all spare parts are relevant for all models.

- Concerning the lamp(s) inside this product and spare part lamps sold separately: These lamps are intended to withstand extreme physical conditions in household appliances, such as temperature, vibration, humidity, or are intended to signal information about the operational status of the appliance. They are not intended to be used in other applications and are not suitable for household room illumination.

## 2.6 Disposal



### **WARNING!**

Risk of injury or suffocation.

- Disconnect the appliance from the mains electrical and water supplies.
- Cut off the mains electrical cable close to the appliance and dispose of it.
- Remove the door catch to prevent children or pets from becoming trapped in the drum.
- Dispose of the appliance in accordance with local requirements for the disposal of Waste Electrical and Electronic Equipment (WEEE).

## 3. PRODUCT DESCRIPTION

### 3.1 Appliance overview

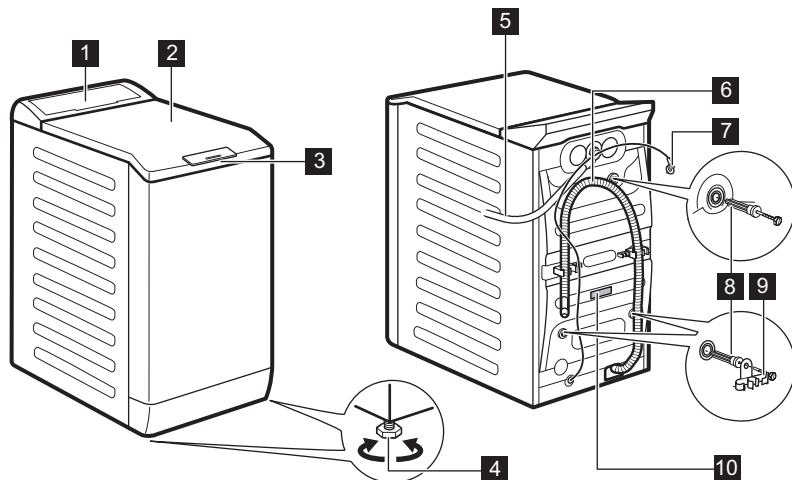

- |          |                                  |           |               |
|----------|----------------------------------|-----------|---------------|
| <b>1</b> | Control panel                    | <b>7</b>  | Mains cable   |
| <b>2</b> | Lid                              | <b>8</b>  | Transit bolts |
| <b>3</b> | Lid handle                       | <b>9</b>  | Hose support  |
| <b>4</b> | Feet for levelling the appliance | <b>10</b> | Rating plate  |
| <b>5</b> | Inlet hose                       |           |               |
| <b>6</b> | Drain hose                       |           |               |

Information for register product.

The **rating plate** reports the model name (**A**), product number (**B**), electrical ratings (**C**) and serial number (**D**).

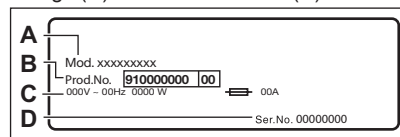

The **info label** reports the model name (**A**), product number (**B**) and serial number (**C**).

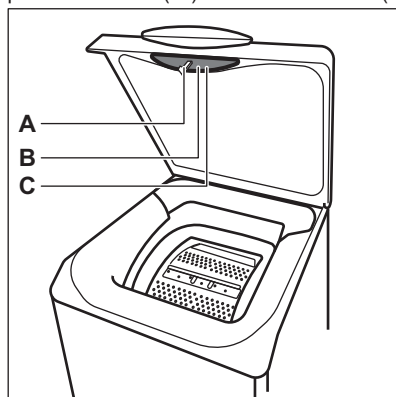

## 4. TECHNICAL DATA

Dimension	Width/ Height/ Total depth	39,7 cm /89,0 cm /59,9 cm
Electrical connection	Voltage	230 V
	Overall power	2200 W
	Fuse	10 A
	Frequency	50 Hz
Level of protection against ingress of solid particles and moisture ensured by the protective cover, except where the low voltage equipment has no protection against moisture		IPX4
Water supply pressure	Minimum	0.5 bar (0.05 MPa)
	Maximum	8 bar (0.8 MPa)
Water supply <sup>1)</sup>		Cold water
Maximum Load	Cotton	6 kg
Spin Speed	Maximum spin speed	951 rpm

<sup>1)</sup> Connect the water inlet hose to a water tap with a 3/4" thread.

## 5. INSTALLATION



**WARNING!**  
Refer to Safety chapters.

### 5.1 Unpacking and positioning

1.

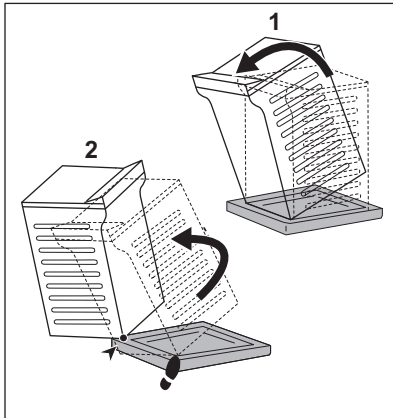

2.

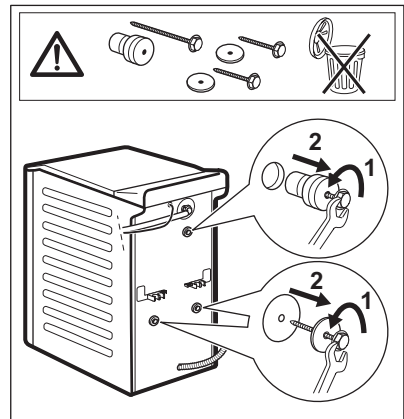



3.

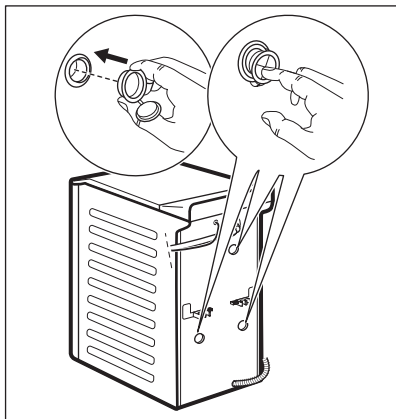

4.



**We recommend that you keep the packaging and the transit bolts for any transport of the appliance.**

Adjust the appliance correctly to prevent vibration, noise and movement of the appliance when it operates.



**WARNING!**  
Do not put cardboard, wood or equivalent materials below the appliance feet to adjust the level.

## 5.2 The inlet hose

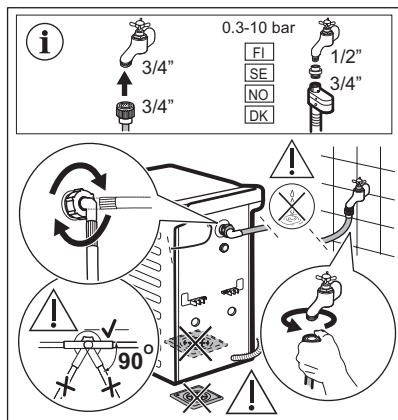

Accessories delivered with the appliance may vary depending on the model.



Make sure there is no damage to hoses and there are no leaks from the couplings. Do not use an extension hose if the inlet hose is too short. Contact the service centre for a replacement inlet hose.

## 5.3 Water drainage

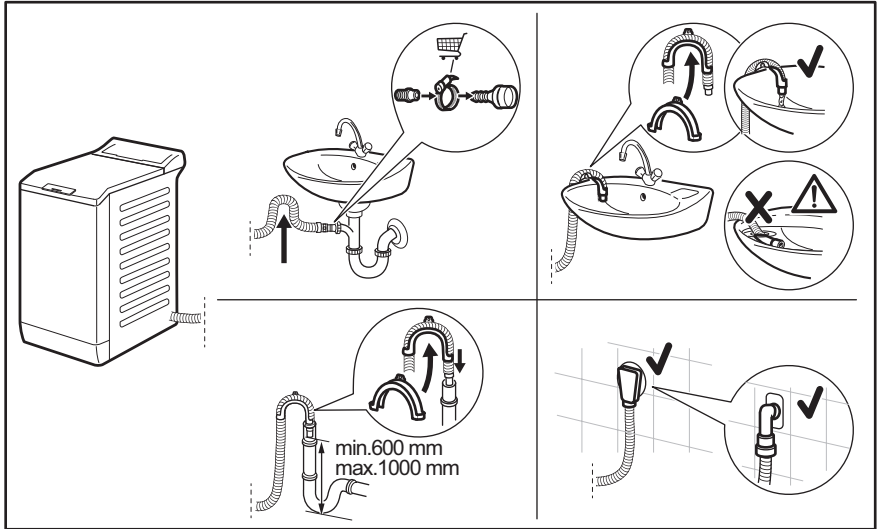

The drain hose should stay at a height of no less than 600 mm and not more than 1000 mm. You can extend the drain hose to maximum 4000 mm. Contact the authorised service centre for the other drain hose and the extension.

## 5.4 Electrical connection

At the end of installation you can connect the mains plug to the mains socket.

The rating plate and the 'Technical Data' chapter indicate the necessary electrical ratings. Make sure that they are compatible with the mains power supply.

Check that your domestic electrical installation can take the maximum load required, also taking into account any other appliances in use.

**Connect the appliance to an earthed socket.**

The power supply cable must be easily accessible after installing the appliance.

For any electrical work required to install this appliance, contact our Authorised Service Centre.



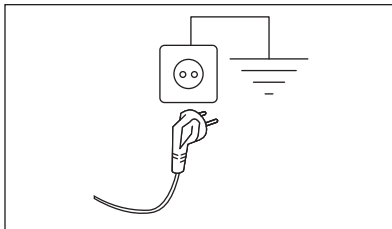



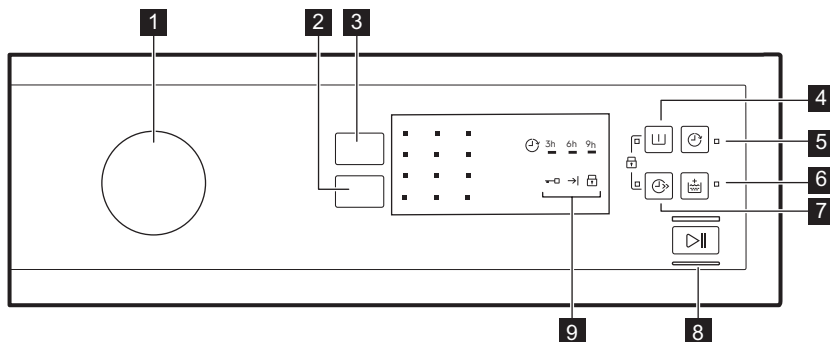

The manufacturer does not accept any responsibility for damage or injury through failure to comply with the above safety precaution.



## 6. CONTROL PANEL



### 6.1 Control panel description



- |   |   |
|---|---|
| <b>1</b> Programme knob   | <b>7</b> Rychlý touchpad       |
| <b>2</b> Odstředování reduction touchpad  | <b>8</b> Start/Pauza touchpad  |
| <b>3</b> Teplota touchpad   | <b>9</b> Indicators   |
| <b>4</b> Předpírka touchpad      | Door locked indicator          |
| <b>5</b> Odložený s. touchpad    | End cycle indicator            |
| <b>6</b> Extra máchání touchpad  | Child lock indicator           |

## 7. PROGRAMME CHART

Programme Default temper- ature Temperature range	Reference spin speed Spin speed range	Maxi- mum load	Programme description (Type of load and level of soiling)
<b>Washing programmes</b>			
Eco 40-60 40 °C <b>1</b> )	1000 rpm (1000- 400 rpm)	6 kg	<b>White cotton and fast-coloured cotton.</b> Normally soiled items. The energy consumption decreases and the time of the washing programme is extended, ensuring good washing results.
Bavlna 40°C 90°C - Cold	1000 rpm (1000- 400 rpm)	6 kg	<b>White cotton and coloured cotton.</b> Normally, heavily and lightly soiled items.
Syntetika 40°C 60°C - Cold	1000 rpm (1000- 400 rpm)	3 kg	<b>Synthetic items or mixed fabric items.</b> Normally soiled items.

Programme Default temperature Temperature range	Reference spin speed Spin speed range	Maximum load	Programme description (Type of load and level of soiling)
Jemné prádlo 30°C 40°C - Cold	1000 rpm (1000- 400 rpm)	2 kg	<b>Delicate fabrics such as acrylics, viscose and mixed fabrics requiring gentler washing.</b> Normally and lightly soiled items.
<b>Special programmes</b>			
 Express Care 40 °C 60 °C - Cold	1000 rpm (1000 - 400 rpm)	3 kg	<b>Cottons and Synthetics.</b> Programme to wash daily laundry in a short time. Normally and lightly soiled items.
 Rychlý 30 min 40°C 40°C - 30°C	1000 rpm (1000- 400 rpm)	3 kg	<b>Synthetic and mixed fabric items.</b> Lightly soiled items.
 Rychlý 14 min 30 °C	800 rpm (800- 400 rpm)	1,5 kg	<b>Synthetic and mixed fabric items.</b> Very light soiling and items to freshen up.
<b>Additional washing programmes</b>			
Odstředování	1000 rpm (1000- 400 rpm)	6 kg	<b>All fabrics, except woollens and delicate fabrics.</b> To spin the laundry and to drain the water in the drum.
Vypouštění	-	6 kg	To drain the water in the drum. <b>All fabrics.</b>
Máchání	1000 rpm (1000- 400 rpm)	6 kg	To rinse and spin the laundry. <b>All fabrics,</b> except woollens and very delicate fabrics. Reduce the spin speed accordingly to the type of laundry.
Antialergický 60 °C	1000 rpm (1000 - 400 rpm)	6 kg	<b>White cotton items.</b> This programme removes micro-organisms thanks to a washing phase with the temperature maintained above 60°C for several minutes. This helps remove germs, bacteria, micro-organism and particles. An additional rinsing phase ensures a proper removal of detergent residues and pollens/allergenic items. In this way the wash is more effective.
Péřová bunda 40 °C 60°C- Cold	800 rpm (800 - 400 rpm)	2 kg	Special programme for one <b>synthetic blanket, duvet, bedspread</b> and so on.
Sport 30 °C 40°C - Cold	1000 rpm (1000 - 400 rpm)	2,5 kg	<b>Synthetic and delicate items.</b> Lightly soiled items or items to refresh.

Programme Default temperature Temperature range	Reference spin speed Spin speed range	Maximum load	Programme description (Type of load and level of soiling)
 Vlna/ Hedvábí 40 °C 40°C - Cold	1000 rpm (1000 - 400 rpm)	1 kg	<b>Machine washable wool, hand washable wool and other fabrics</b> with «hand washing» care symbol <sup>2)</sup> .

<sup>1)</sup> According to Commission Regulation EU 2019/2023, this programme at 40 °C is able to clean normally soiled cotton laundry declared to be washable at 40 °C or 60 °C, together in the same cycle.



















For the reached temperature in the laundry, the programme duration and other data, please refer to 'Consumption Values' chapter.

The most efficient programmes in terms of energy consumption are generally those that perform at lower temperatures and longer duration.





<sup>2)</sup> During this cycle the drum rotates slowly to ensure a gentle wash. It can seem that the drum doesn't rotate or doesn't rotate properly, but this is normal for this programme.

### Programme options compatibility

Programme	OPTIONS Odstředování						
Eco 40-60	■	■	■	■	■	■	■
Bavlna	■	■	■	■	■	■	■
Syntetika	■	■	■	■	■	■	■
Jemné prádlo	■	■	■	■	■	■	■
Express Care 	■	■	■	■	■	■	■
Rychlý 30 min 	■	■	■	■	■	■	■
Rychlý 14 min 	■	■	■	■	■	■	■
Odstředování	■	■	■	■	■	■	■
Vypouštění	■	■	■	■	■	■	■
Máchání	■	■	■	■	■	■	■
Antialergický	■	■	■	■	■	■	■
Péřová bunda	■	■	■	■	■	■	■

Programme	Odstředování	OPTIONS					
							
Sport	■	■	■		■	■	■
Vlna/Hedvábí 	■	■	■	■		■	

### Suitable detergents for washing programmes

Programme	Universal powder <sup>1)</sup>	Liquid Uni- versal	Liquid for coloureds	Delicates woollens	Special
Eco 40-60	▲	▲	▲	--	--
Bavlna	▲	▲	▲	--	--
Syntetika	▲	▲	▲	--	--
Jemné prádlo	--	--	--	▲	▲
Express Care  min	--	▲	▲	--	--
Rychlý 30 min  min	--	▲	▲	--	--
Rychlý 14 min  min	--	▲	▲	--	--
Antialergický	▲	▲	--	--	▲
Péřová bunda	--	--	--	▲	▲
Sport	--	▲	▲	--	▲
Vlna/Hedvábí 	--	--	--	▲	▲

<sup>1)</sup> At temperature higher than 60 °C the use of powder detergent is recommended.

▲ = Recommended

-- = Not recommended

## 7.1 Woolmark Apparel Care - Blue



The wool wash cycle of this machine has been approved by The Woolmark Company for the washing of wool garments labeled as «hand wash» provided that the garments are washed according to the instructions issued by the manufacturer of this washing machine. Follow the garment care label for drying and other laundry instructions. M1145

The Woolmark symbol is a Certification mark in many countries.

## 8. OPTIONS

### 8.1 Introduction



The options/functions are not available with all washing programmes. Check the compatibility between options/functions and washing programmes in the "Programme Chart". An option/function can exclude another one, in this case the appliance doesn't allow you to set incompatible options/functions.

### 8.2 Teplota

Set this option to change the default temperature.

Indicator **\*** = cold water.

The indicator of the set temperature comes on.

### 8.3 Odstředování

With this option you can change the default spin speed.

The indicator of the set speed comes on.

#### Additional spin options:

##### No Spin

- Set this option to deactivate all spin phases. Only the drain phase is available.
- The related indicator comes on.
- Set this option for very delicate fabrics.

- The rinses phase uses more water for some washing programmes.

##### Rinse Hold

- Set this option to prevent the laundry creases.
- The related indicator comes on.
- There is a water in the drum when the programme is completed.
- The drum turns regularly to prevent the laundry creases.
- The lid stays locked. You must drain the water to unlock the lid.



To drain the water refer to 'At the end of the programme'.

##### Night Cycle

- Set this option to remove all spin phases and to perform a silent washing.
- The rinse phase uses more water for some washing programmes.
- The related indicator comes on.
- The washing programme stops with the water in the drum. The drum turns regularly to prevent the laundry creases.
- The lid stays locked. You must drain the water to unlock the lid.



To drain the water refer to 'At the end of the programme'.

## 8.4 Předpírka

With this option you can add a prewash phase to a washing programme.

The relevant indicator illuminates.

- Use this option to add a pre-wash phase before the washing phase. This option is recommended for heavily soiled laundry, especially if containing sand, dust, mud and other solid particles.

 This option can increase the programme duration.

## 8.5 Odložení s.

With this option you can delay the start of a programme by 9, 6 or 3 hours.

The indicator of the option and the indicator of the set value are on.

After touching the Start/Pauza  button the appliance begins the countdown. The lid is locked.

## 8.6 Extra máchání

With this option you can add a few rinses according to the selected washing programme.

Use this option for people with allergies to detergent residues and with sensitive skin.

 This option increases the programme duration.

The corresponding indicator illuminates.

## 8.7 Rychlý

With this option you can decrease the programme duration.

Use this option for items with light soil or items to refresh.

The related indicator comes on.

This option is not available for every programme. For more details, refer to Programme options compatibility in "Programmes" chapter.



## 8.8 Start/Pauza

Touch the Start/Pauza  button to start, pause the appliance or interrupt a running programme.



# 9. SETTINGS

## 9.1 Child Lock

With this option you can prevent that the children play with the control panel.



- To **activate/deactivate** this option, press  and  at the same time until the indicator  **comes on/goes off**.

You can activate this option:

- After you press : the options and the programme knob are locked.
- Before you press : the appliance cannot start.

## 9.2 Acoustic signals

The acoustic signals operate when:

- The programme is completed.
  - The appliance has a malfunction.
- To **deactivate/activate** the acoustic signals, press  and  at the same time for 3 seconds.

 If you deactivate the acoustic signals, they continue operate when the appliance has a malfunction.



## 10. BEFORE FIRST USE

- i** During installation or before first use you may observe some water in the appliance. This is residual water left in the appliance after a full functional test in the factory to ensure the appliance is delivered to customers in perfect working order and is no cause for concern.

1. Connect the mains plug to the mains socket.
2. Open the water tap.
3. Put a small quantity of detergent in the compartment for washing phase.
4. Set and start a programme for cotton at the highest temperature without laundry.

This removes all possible dirt from the drum and the tub.

## 11. DAILY USE

- !** **WARNING!**  
Refer to Safety chapters.

### 11.1 Loading the laundry

1. Open the appliance lid.
2. Push the button **A**.

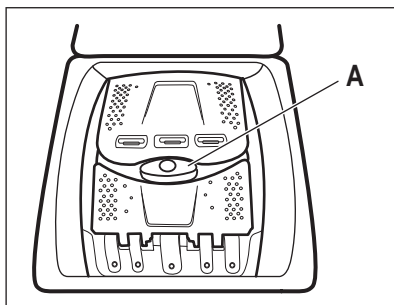

The drum opens automatically.

3. Put the laundry in the drum, one item at a time.
  4. Shake the items before you put them in the appliance.
- Make sure not to put too much laundry in the drum.
5. Close the drum and the lid.

- !** **CAUTION!**  
Before you close the lid of your appliance, make sure that you close the drum correctly.

### 11.2 Detergent compartments. Using detergent and additives

1. Measure out specified detergents and the fabric conditioner.
2. Put the detergent and the fabric conditioner into the proper compartments.

- i** Always follow the instructions that you find on the packaging of the detergent products, but we recommend that you do not exceed the maximum indicated level. This quantity will however guarantee the best washing results.

- i** When using liquid detergents add them into a dosing ball (supplied by the detergent's manufacturer). Put the dosing ball inside the washing machine's drum, on top of the garments.

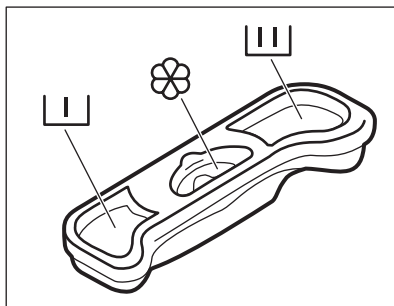

---

 Detergent compartment for prewash phase.

---

 Detergent compartment for washing phase.

---



Compartment for liquid additives (fabric conditioner, starch).

The mark  is the maximum level for the quantity liquid additives.

---

### 11.3 Setting a programme



1. Turn the programme knob and set the programme:
  - The indicator of the  flashes.
2. If necessary, change the temperature and the spin speed or add available options. When you activate an option, the indicator of the set option comes on.



If you set something incorrect, the indicator  flashes red.

### 11.4 Starting a programme without the delay start

Press the .

- The indicator of the  stops to flash and stays on.
- The programme starts, the lid locks, the indicator  is on.
- The drain pump can operate for a short time at the beginning of the washing cycle.

### 11.5 Starting a programme with the delay start

1. Press  to set the delay you want to set.



The indicator of the set delay is on. The indicator  is on.

2. Press :
  - The appliance starts the countdown.
  - When the countdown is completed, the programme starts automatically.



You can cancel or change the set of the delay start before you press the .

To cancel the delay start :

- a. Press  to set the appliance to pause
- b. Press  until the indicator of the set delay goes off.  
Press  again to start the programme immediately.

### 11.6 The AutoSense System load detection

After touching the Start/Pauza  button:



The AutoSense System starts estimating the weight of the load to calculate the real programme duration. The appliance automatically adjusts the programme duration to the load to achieve perfect washing results in the minimum possible time



The AutoSense System is not available with all programmes such as : Vlna/Hedvábí, Rychlý 14 min and programmes with short cycles.

### 11.7 Interrupting a programme and changing the options

You can change only some options before they operate.

1. Press .  
The indicator flashes.
2. Change the options.
3. Press  again.  
The programme continues.

## 11.8 Cancelling a running programme

1. Turn the programme knob to position  to cancel the programme and to deactivate the appliance.
2. Turn the programme knob again to activate the appliance. Now, you can set a new washing programme.



Before starting the new programme the appliance could drain the water. In this case, make sure that the detergent is still in the detergent compartment, if not fill the detergent again.

## 11.9 Opening the lid



While a programme or the delay start operates, the appliance lid is locked. The indicator  is on.



### CAUTION!

If the temperature and level of the water in the drum are too high, you cannot open the lid.

**Open the lid during the first 10 minutes of the cycle and when the delay start operates:**





1. Press the  to pause the appliance.
2. Wait until the lid lock indicator  goes off.
3. You can open the lid.
4. Close the lid and press the  again. The programme (or the delay start) continues.

**Open the lid when the programme operates:**



1. Turn the programme knob to position  to deactivate the appliance.
2. Wait for some minutes and then open the appliance lid.
3. Close the lid and set the programme again.

## 11.10 At the end of the programme





- The appliance stops automatically.

- The acoustic signal operates (if it is activated).
- The indicator of the button  goes off.
- The lid lock indicator  goes off.
- The indicator  is on.
- You can open the lid.
- Remove the laundry from the appliance. Make sure that the drum is empty.
- Close the water tap.
- Turn the programme knob to position  to deactivate the appliance.
- Keep the lid ajar, to prevent the mildew and odours.

**The washing programme is completed, but there is water in the drum:**

- The drum turns regularly to prevent the creases in the laundry.
- The lid lock indicator  is on. The indicator  flashes. The lid stays locked.
- You must drain the water to open the lid.

**To drain the water:**

1. If necessary, decrease the spin speed. If you set , the appliance only drains.
2. Press . The appliance drains the water and spins.
3. When the programme is completed and the lid lock indicator  goes off, you can open the lid.
4. Turn the programme knob to position  to deactivate the appliance.



The appliance drains and spins automatically after approximately 18 hours (except for Wool programme).

## 11.11 Stand-by

Some minutes after the end of the washing programme, if you do not deactivate the appliance, the energy saving status activates.

The energy saving status decreases the energy consumption when the appliance is on the stand by.

- All indicators go off.
- The indicator of the  flashes slowly .
- Press one of the options to deactivate the energy saving status.

## 12. HINTS AND TIPS



### WARNING!

Refer to Safety chapters.

### 12.1 The laundry load

- Divide the laundry into: white, coloured, synthetics, delicates and wool.
- Follow the washing instructions on the laundry care labels.
- Do not wash white and coloured items together.
- Some coloured items can discolour with the first wash. We recommend that you wash them separately for the first couple of times.
- Turn multilayered fabrics, wool and items with printed illustrations inside out.
- Pre-treat stubborn stains.
- Wash stubborn stains with a special detergent.
- Be careful with curtains. Remove the hooks and put the curtains in a washing bag or pillowcase.
- A very small load can cause balance problems with the spin phase leading to excessive vibration. If this occurs:
  - a. interrupt the programme and open the door (refer to "Daily Use" chapter);
  - b. manually redistribute the load so that the items are spaced evenly around the tub;
  - c. press the Start/Pauza button. The spin phase continues.
- Avoid washing garments full of long animal hair or poor quality garments releasing lots of fluff that could block the drain circuit and therefore requiring the Service assistance.
- Button up pillowcases, close zippers, hooks and poppers. Tie up belts,



If you set a programme or an option that ends with water in the drum, the energy saving status function **doesn't activate** to remind you to drain the water.

cords, shoelaces, ribbons and any other loose elements.

- Do not wash laundry without hems or with cuts. Use a washing bag to wash small and/or delicate items (e.g. underwired bras, belts, tights, shoelaces, ribbons, etc. ).

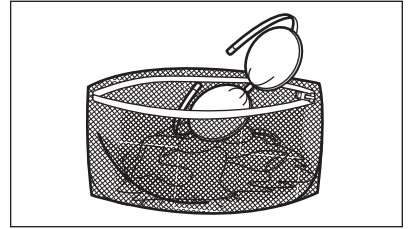

- Empty pockets and unfold the items.

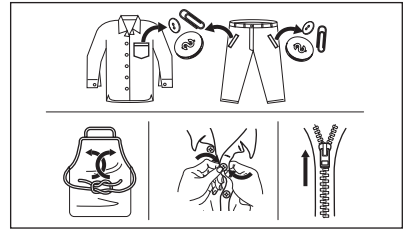

### 12.2 Stubborn stains

For some stains, water and detergent is not sufficient.

We recommend that you pre-treat these stains before you put the items in the appliance.

Special stain removers are available. Use the special stain remover that is applicable to the type of stain and fabric.

## 12.3 Detergent type and quantity

The choice of detergent and use of correct quantities not only affects your wash performance, but also helps to avoid waste and protect the environment:

- Use only detergents and other treatments specially made for washing machines. First, follow these generic rules:
  - powder detergents for all types of fabric, excluding delicate. Prefer powder detergents containing bleach for whites and laundry sanitization,
  - liquid detergents, preferably for low temperature wash programmes (60 °C max) for all types of fabric, or special ones for woollens only.
- The choice and quantity of detergent will depend on: type of fabric (delicates, woollens, cottons, etc), the colour of clothes, size of the load, degree of soiling, wash temperature and hardness of the water used.
- Follow the instructions that you find on packaging of the detergents or other treatments without exceeding the indicated maximum level (**MAX**).
- Do not mix different types of detergents.
- Use less detergent if:
  - you are washing a small load,
  - the laundry is lightly soiled,
  - there is large amounts of foam during washing.
- When using detergent tabs or pods, always put them inside the drum, not in the detergent dispenser.

### Insufficient detergent may cause:

- unsatisfactory washing results,
- the wash load to turn grey,
- greasy clothes,
- mould in the appliance.

### Excessive detergent may cause:

- sudsing,
- reduced washing effect,
- inadequate rinsing,
- a greater impact for the environment.

## 12.4 Ecological hints

To save water, energy and to help protect the environment, we recommend that you follow these tips:

- **Normally soiled laundry** may be washed **without prewash** in order to save detergent, water and time (the environment is protected too!).
- Loading the appliance to the **maximum capacity indicated for each programme helps to reduce energy and water consumption**.
- With adequate pre-treatment, stains and limited soiling can be removed; the laundry can then be washed at a lower temperature.
- To use the correct quantity of detergent, refer to the quantity suggested by the detergent producer and check the water hardness of your domestic system. Refer to 'Water hardness'.
- Set the **maximum possible spin speed** for the selected washing programme **before drying your laundry in a tumble dryer**. This will save energy during drying!

## 12.5 Water hardness

If the water hardness in your area is high or moderate, we recommend that you use a water softener for washing machines. In areas where the water hardness is soft it is not necessary to use a water softener.

To find out the water hardness in your area, contact your local water authority.

Use the correct quantity of water softener. Follow the instructions that you find on the packaging of the product.

# 13. CARE AND CLEANING



### WARNING!

Refer to Safety chapters.

## 13.1 Periodic cleaning schedule

**Periodic cleaning helps to extend the life of your appliance.**

After each cycle, keep the door and the detergent dispenser slightly ajar to get air circulation and dry the humidity inside the appliance: this will prevent mildew and odours.

If the appliance is not used for a long time: close the water tap and unplug the appliance.

#### Indicative periodic cleaning schedule:

Descaling	Twice a year
Maintenance wash	Once a month
Clean lid seal	Every two months
Clean drum	Every two months
Clean detergent dispenser	Every two months
Clean the inlet hose and the valve filter	Twice a year

The following paragraphs explain how you should clean each part.

### 13.2 Removing foreign objects

-  Make sure that pockets are empty and all loose elements are tied up before running your cycle. Refer to 'The laundry load' in 'Hints and tips'.

Remove any foreign objects (such as metal clip, buttons, coins, etc) that you may find in the inlet hose filter and the drum. Refer to 'Cleaning the drum' and 'Cleaning the inlet hose and the valve filter' paragraphs. If necessary, please contact the Authorised Service Centre.

### 13.3 External cleaning

Clean the appliance with mild soap and warm water only. Fully dry all the surfaces. Do not use a scouring pads or any scratching material.



**CAUTION!**  
Do not use alcohol, solvents or chemical products.



**CAUTION!**  
Do not clean the metal surfaces with chlorine-based detergent.

### 13.4 Descaling



If the water hardness in your area is high or moderate, we recommend that you use a water descaling product for washing machines.

Regularly examine the drum to check for limescale.

Regular detergents already contain water softening agents, but we recommend to run a cycle with an empty drum and a descaling product occasionally.



Always follow the instructions that you find on the packaging of the product.

### 13.5 Maintenance wash

The repeated and prolonged use of low temperature programmes can cause detergent deposits, fluff residues, bacterial growth inside the drum and the tub. This could generate bad odours and mildew. To eliminate these deposits and clean the inner part of the appliance, run a maintenance wash regularly (at least once a month).



Refer to Cleaning the drum chapter.

### 13.6 Cleaning the drum

Regularly examine the drum to prevent unwanted deposits.

Rust deposits in the drum may occur due to rusting foreign body in the washing or tap water containing iron

Clean the drum with special products for stainless steel.

- i** Always follow the instructions that you find on the packaging of the product.  
Do not clean the drum with acidic descaling products, scouring products containing chlorine or iron or steel wool.

For a thorough clean:

1. Remove all laundry from the drum.
2. Run a Bavlna programme with the highest temperature.
3. Add a small quantity of powder detergent into the empty drum, in order to rinse out any left residues.

### 13.8 Cleaning the detergent dispenser

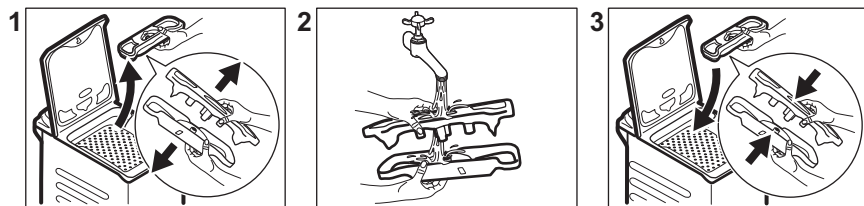

### 13.9 Cleaning the inlet hose and the valve filter

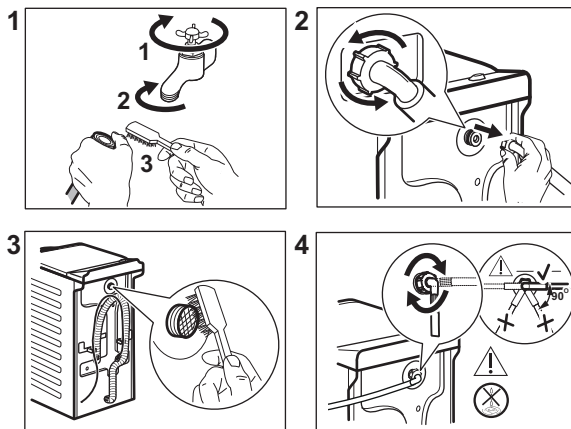

### 13.10 Frost precautions

If the appliance is installed in an area where the temperature can be less than 0°C, remove the remaining water from the inlet hose and the drain pump.

### 13.7 Lid seal

Regularly examine the seal and remove all objects from the inner part. Clean it when needed, using ammonia cream cleanser agent without scratching the seal surface.

- i** Always obey the instructions that you find on the packaging of the product.

- i** Do this procedure also when you want to do the emergency drain.

1. Close the water tap.
2. Remove the water inlet hose.

3. Remove the drain hose from the rear support and unhook it from sink or spigot.
4. Put the ends of each drain and inlet hose in a container. Let the water flow out of the hoses.
5. Set the Vypouštění programme and let it operate until the end of the cycle.
6. Turn the programme knob to position Zap./Vyp. ① to deactivate the appliance.
7. Disconnect the appliance from the mains socket.

**WARNING!**

Make sure that the temperature is more than 0°C before you use the appliance again. The manufacturer is not responsible for damages caused by low temperatures.

## 14. TROUBLESHOOTING

**WARNING!**

Refer to Safety chapters.

### 14.1 Alarm Codes and Possible failures

The appliance does not start or it stops during operation. First try to find a solution to the problem (refer to the tables).

**WARNING!**

Deactivate the appliance before carrying out any check.

With some problems, the acoustic signals operate. The **red** indicator of the button Start/Pauza flashes and one of the phase indicators comes on, to show an alarm code:

Problem	Possible solution
 <p>The appliance does not fill with water properly.</p>	<ul style="list-style-type: none"> <li>• Make sure that the water tap is open.</li> <li>• Make sure that the pressure of the water supply is not too low. For this information, contact your local water authority.</li> <li>• Make sure that the water tap is not clogged.</li> <li>• Make sure that the inlet hose has no kinks, damages or bends.</li> <li>• Make sure that the connection of the water inlet hose is correct.</li> <li>• This problem may be caused by the filter of the inlet hose or by the clogged drain circuit. Please contact the Authorised Service Centre.</li> <li>• Make sure that the filter of the inlet hose and the filter of the valve are not clogged. Refer to 'Care and cleaning'.</li> </ul>



<p>→ </p> <p>The appliance does not drain the water.</p>	<ul style="list-style-type: none"> <li>• Make sure that the sink spigot is not clogged.</li> <li>• Make sure that the drain hose has no kinks or bends.</li> <li>• This problem may be caused by the clogged drain circuit. Please contact the Authorised Service Centre.</li> <li>• Make sure that the connection of the drain hose is correct.</li> <li>• Set the drain programme if you set a programme without drain phase.</li> <li>• Set the drain programme if you set an option which ends with water in the tub.</li> </ul>
<p>⏏</p> <p>The appliance drum doors are open or not closed correctly.</p>	<ul style="list-style-type: none"> <li>• Make sure that drum doors are properly closed.</li> </ul>
<p>The indicator of button Start/Pauza flashes in red 11 times and 1 (or 2 or 3) time(s) in yellow: the mains supply is unstable. Wait until mains supply is stable.</p>	

In case of different problem with the washing machine check the table below for possible solutions.

<b>Problem</b>	<b>Possible solution</b>
<p>The programme does not start.</p>	<ul style="list-style-type: none"> <li>• Make sure that the mains plug is connected to the mains socket.</li> <li>• Make sure that the appliance lid and drum door are closed.</li> <li>• Make sure that there is no damaged fuse in the fuse box.</li> <li>• Make sure that the Start/Pauza  has been touched.</li> <li>• If the delay start is set, cancel the setting or wait for the end of countdown.</li> <li>• Deactivate the Child Lock function if it is on.</li> <li>• Check the position of the knob on the selected programme.</li> </ul>
<p>The appliance fills with water and drains immediately.</p>	<ul style="list-style-type: none"> <li>• Make sure that the drain hose is in the correct position. The hose may be positioned too low. Refer to "Installation instruction".</li> </ul>
<p>The spin phase does not operate or the washing cycle lasts longer than usual.</p>	<ul style="list-style-type: none"> <li>• Set the spin programme.</li> <li>• This problem may be caused by the clogged drain circuit. Please contact the Authorised Service Centre.</li> <li>• Adjust manually the items in the tub and start the spin phase again. This problem may be caused by balance problems.</li> </ul>
<p>There is water on the floor.</p>	<ul style="list-style-type: none"> <li>• Make sure that the couplings of the water hoses are tight and there is not water leakages.</li> <li>• Make sure that the water inlet hose and the drain hose have no damages.</li> <li>• Make sure you use the correct detergent and the correct quantity of it.</li> </ul>

Problem	Possible solution
You cannot open the appliance lid.	<ul style="list-style-type: none"> <li>• Make sure that a washing programme that ends with water in tub, has not been selected.</li> <li>• Make sure that the washing programme is finished.</li> <li>• Set the drain or the spin programme if there is water in the drum.</li> <li>• Make sure that the appliance receives electrical power.</li> <li>• This problem may be caused by a failure of the appliance. Contact the Authorised Service Centre.</li> </ul>
The appliance makes an unusual noise and vibrates.	<ul style="list-style-type: none"> <li>• Make sure the levelling of the appliance is correct. Refer to "Installation instruction".</li> <li>• Make sure that the packaging and/or the transit bolts are removed. Refer to "Installation instruction".</li> <li>• Add more laundry in the drum. The load may be too small.</li> </ul>
The programme duration increases or decreases during programme execution.	<ul style="list-style-type: none"> <li>• The AutoSense System is able to adjust the programme duration according to the type and the laundry load size. Refer to "The AutoSense System load detection" in "Daily Use" chapter.</li> </ul>
The washing results are not satisfactory.	<ul style="list-style-type: none"> <li>• Increase the detergent quantity or use a different detergent.</li> <li>• Use special products to remove the stubborn stains before you wash the laundry.</li> <li>• Make sure that you set the correct temperature.</li> <li>• Decrease the laundry load.</li> </ul>
Too much foam in the drum during the washing cycle.	<ul style="list-style-type: none"> <li>• Reduce the quantity of detergent.</li> </ul>

After the check, activate the appliance. The programme continues from the point of interruption.

If the problem occurs again, contact the Authorised Service Centre. The necessary data for the service centre is on the rating plate.

## 15. CONSUMPTION VALUES

### 15.1 Introduction



See the web link [www.theenergylabel.eu](http://www.theenergylabel.eu) for detailed information about Energy Label.

- i** The QR code on the energy label supplied with the appliance provides a web link to the information related to the performance of the appliance in the EU EPREL database. Keep the energy label for reference together with the user manual and all other documents provided with this appliance. It is also possible to find the same information in EPREL using the link <https://eprel.ec.europa.eu> and the model name and product number that you find on the rating plate of the appliance. Refer to 'Product description' chapter for the position of the rating plate.

## 15.2 Legend

<b>kg</b>	Laundry load.	<b>h:mm</b>	Programme duration.
<b>kWh</b>	Energy consumption.	<b>°C</b>	Temperature in the laundry.
<b>Litres</b>	Water consumption.	<b>rpm</b>	Spin speed.
<b>%</b>	Remaining moisture at the end of spinning phase. The higher is the spin speed, the higher is the noise and the lower is the remaining moisture.		

- i** Values and programme duration may differ depending on different conditions (e.g. room temperature, water temperature and pressure, load size and type of laundry, supply voltage) and also if you change the default setting of a programme.

## 15.3 According to Commission Regulation Eu 2019/2023

<b>Eco 40-60 programme</b>	<b>kg</b>	<b>kWh</b>	<b>Litres</b>	<b>h:mm</b>	<b>%</b>	<b>°C</b>	<b>rpm<sup>1)</sup></b>
Full load	6	0.940	47	3:17	60	47	951
Half load	3	0.518	37	2:35	60	39	951
Quarter load	1,5	0.260	29	2:35	62	25	951

<sup>1)</sup> Maximum spin speed.

### Power consumption in different modes

<b>Off (W)</b>	<b>Stand-by (W)</b>	<b>Delay start (W)</b>
0.48	0.48	4.00
Time to Off/Standby mode is 15 minutes maximum.		

## 15.4 Common programmes

 These values are indicative only.

Programme	kg	kWh	Litres	h:mm	%	°C	rpm <sup>1)</sup>
Bavlna <sup>2)</sup> 90°C	6	2.60	85	3:25	60	85	1000
Bavlna 60°C	6	1.85	85	3:25	60	55	1000
Bavlna 20° <sup>3)</sup> 20°C	6	0.40	85	2:45	60	20	1000
Syntetika 40°C	3	0.65	55	2:10	37	40	1000
Jemné prádlo <sup>4)</sup> 30°C	2	0.35	50	1:00	37	30	1000
Vlna/Hedvábí 30°C	1	0.20	35	1:10	32	30	1000

1) Reference indicator of the spin speed.

2) Suitable for washing heavily soiled textiles.

3) Suitable for washing lightly soiled cottons, synthetic and mixed fabrics.

4) It also performs as quick washing cycle for lightly soiled laundry.

## 16. QUICK GUIDE

### 16.1 Daily use

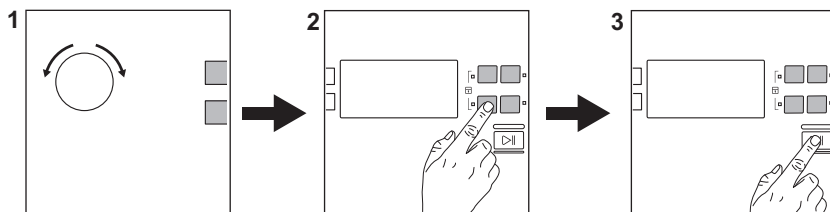

Connect the mains plug to the mains socket.

Open the water tap.





Load the laundry.

Pour the detergent and other treatment in the proper compartment of the detergent dispenser.

1. Turn the programme dial to set the desired programme.
2. Set the desired options by means of the corresponding touch buttons.
3. To start the programme, touch the **Start/Pauza**  button.

At the end of the programme, remove the laundry. Set the programme dial on ① to turn off the appliance.

## 16.2 Programmes

Programmes	Load	Product description
<b>Eco 40-60</b>	6 kg	White and coloured cottons. Normally soiled garments.
<b>Bavlna</b>	6 kg	White cotton and coloured cotton.
<b>Syntetika</b>	3 kg	Synthetic items or mixed fabric items.
<b>Jemné prádlo</b>	2 kg	Delicate fabrics such as acrylics, viscose, polyester items.
 <b>Express Care</b>	3 kg	Cottons and synthetics. Short programme for daily laundry.
 <b>Rychlý 30 min</b>	3 kg	Synthetic and mixed fabric items. Lightly soiled items.
 <b>Rychlý 14 min</b>	1,5 kg	Cotton and synthetic lightly soiled items or once worn items.
<b>Odstředování</b>	6 kg	All fabrics, except woollens and very delicate fabrics. Programme for spinning.
<b>Vypouštění</b>	6 kg	All fabrics, except woollens and very delicate fabrics. Programme for draining the water.
<b>Máchání</b>	6 kg	All fabrics, except woollens and very delicate fabrics. Programme for rinsing and spinning.
<b>Antialergický</b>	6 kg	White cotton items. This programme helps to remove germs and bacteria.
<b>Pěřová bunda</b>	2 kg	Single synthetic blanket, padded clothes, duvets, down jackets.
<b>Sport</b>	2,5 kg	Sportswear.
 <b>Vlna/Hedvábí</b>	1 kg	Machine washable wool, hand washable wool and delicates.

## 17. ENVIRONMENTAL CONCERNS

Recycle materials with the symbol . Put the packaging in relevant containers to recycle it. Help protect the environment and human health by recycling waste of electrical and electronic appliances. Do not dispose of

appliances marked with the symbol  with the household waste. Return the product to your local recycling facility or contact your municipal office.





[www.electrolux.com/shop](http://www.electrolux.com/shop)



135997740-A-122021

